

SKKT 57, SKKH 57, SKKT 57B



SEMIPACK[®] 1

Thyristor / Diode Modules

SKKT 57
SKKH 57
SKKT 57B

Features

- Heat transfer through aluminium oxide ceramic isolated metal baseplate
- Hard soldered joints for high reliability
- UL recognized, file no. E 63 532

Typical Applications*

- DC motor control (e. g. for machine tools)
- AC motor soft starters
- Temperature control (e. g. for ovens, chemical processes)
- Professional light dimming (studios, theaters)

1) See the assembly instructions

| V_{RSM} V | V_{RRM}, V_{DRM} V | $I_{TRMS} = 95$ A (maximum value for continuous operation) | | |
|----------------|-------------------------|--|-------------|-------------|
| | | $I_{TAV} = 55$ A (sin. 180; $T_c = 80$ °C) | | |
| 900 | 800 | SKKT 57/08E | SKKT 57B08E | SKKH 57/08E |
| 1300 | 1200 | SKKT 57/12E | SKKT 57B12E | SKKH 57/12E |
| 1500 | 1400 | SKKT 57/14E | SKKT 57B14E | SKKH 57/14E |
| 1700 | 1600 | SKKT 57/16E | SKKT 57B16E | SKKH 57/16E |
| 1900 | 1800 | SKKT 57/18E | SKKT 57B18E | SKKH 57/18E |

| Symbol | Conditions | Values | Units |
|------------------|---|----------------------------|------------------|
| I_{TAV} | sin. 180; $T_c = 85$ (100) °C; | 50 (35) | A |
| I_D | P3/180; $T_a = 45$ °C; B2 / B6 | 57 / 68 | A |
| | P3/180F; $T_a = 35$ °C; B2 / B6 | 100 / 130 | A |
| I_{RMS} | P3/180F; $T_a = 35$ °C; W1 / W3 | 130 / 3 x 100 | A |
| I_{TSM} | $T_{vj} = 25$ °C; 10 ms | 1500 | A |
| | $T_{vj} = 125$ °C; 10 ms | 1250 | A |
| i^2t | $T_{vj} = 25$ °C; 8,3 ... 10 ms | 11000 | A ² s |
| | $T_{vj} = 125$ °C; 8,3 ... 10 ms | 8000 | A ² s |
| V_T | $T_{vj} = 25$ °C; $I_T = 200$ A | max. 1,65 | V |
| $V_{T(TO)}$ | $T_{vj} = 125$ °C | max. 0,9 | V |
| r_T | $T_{vj} = 125$ °C | max. 3,5 | mΩ |
| I_{DD}, I_{RD} | $T_{vj} = 125$ °C; $V_{RD} = V_{RRM}, V_{DD} = V_{DRM}$ | max. 15 | mA |
| t_{gd} | $T_{vj} = 25$ °C; $I_G = 1$ A; $di_G/dt = 1$ A/μs | 1 | μs |
| t_{gr} | $V_D = 0,67 * V_{DRM}$ | 2 | μs |
| $(di/dt)_{cr}$ | $T_{vj} = 125$ °C | max. 150 | A/μs |
| $(dv/dt)_{cr}$ | $T_{vj} = 125$ °C | max. 1000 | V/μs |
| t_q | $T_{vj} = 125$ °C, | 80 | μs |
| I_H | $T_{vj} = 25$ °C; typ. / max. | 150 / 250 | mA |
| I_L | $T_{vj} = 25$ °C; $R_G = 33$ Ω; typ. / max. | 300 / 600 | mA |
| V_{GT} | $T_{vj} = 25$ °C; d.c. | min. 3 | V |
| I_{GT} | $T_{vj} = 25$ °C; d.c. | min. 150 | mA |
| V_{GD} | $T_{vj} = 125$ °C; d.c. | max. 0,25 | V |
| I_{GD} | $T_{vj} = 125$ °C; d.c. | max. 6 | mA |
| $R_{th(j-c)}$ | cont.; per thyristor / per module | 0,57 / 0,29 | K/W |
| $R_{th(j-c)}$ | sin. 180; per thyristor / per module | 0,6 / 0,3 | K/W |
| $R_{th(j-c)}$ | rec. 120; per thyristor / per module | 0,64 / 0,32 | K/W |
| $R_{th(c-s)}$ | per thyristor / per module | 0,2 / 0,1 | K/W |
| T_{vj} | | - 40 ... + 125 | °C |
| T_{stg} | | - 40 ... + 125 | °C |
| V_{isol} | a. c. 50 Hz; r.m.s.; 1 s / 1 min. | 3600 / 3000 | V~ |
| M_s | to heatsink | 5 ± 15 % ¹⁾ | Nm |
| M_t | to terminals | 3 ± 15 % | Nm |
| a | | $5 * 9,81$ | m/s ² |
| m | approx. | 95 | g |
| Case | SKKT | A 46 | |
| | SKKT ...B | A 48 | |
| | SKKH | A 47 | |



SKKT **SKKH**

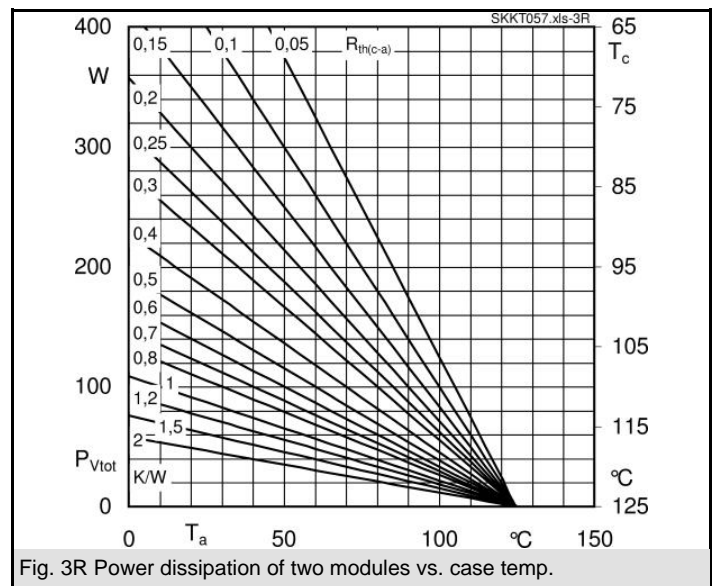
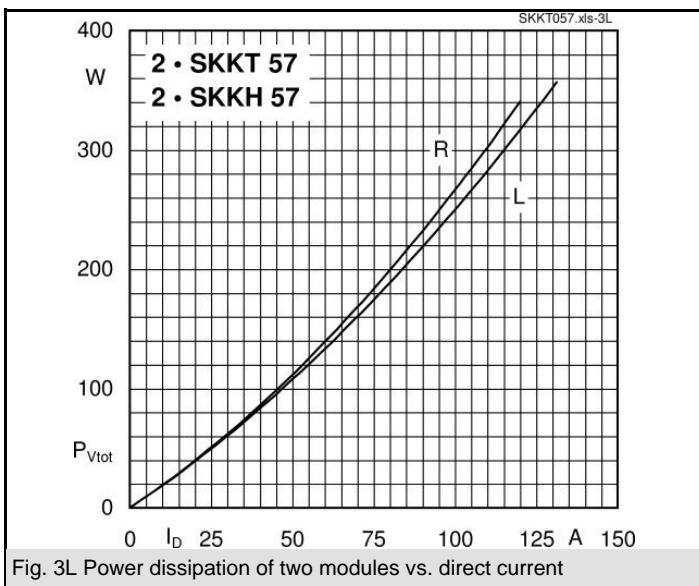
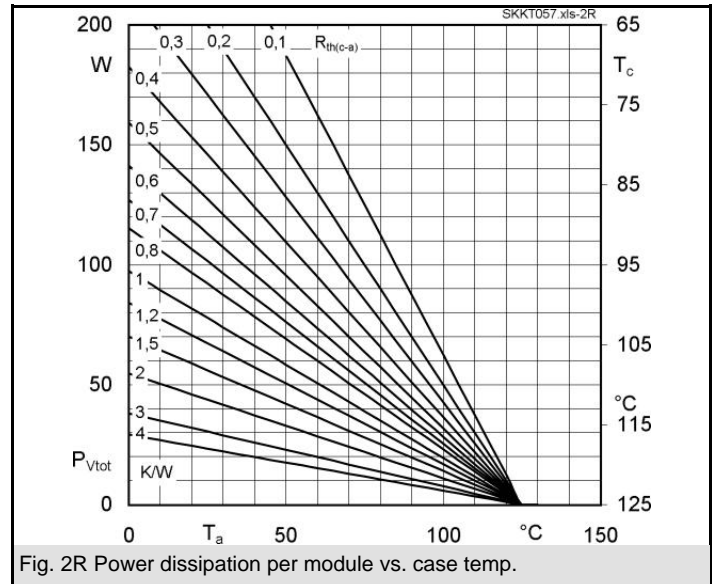
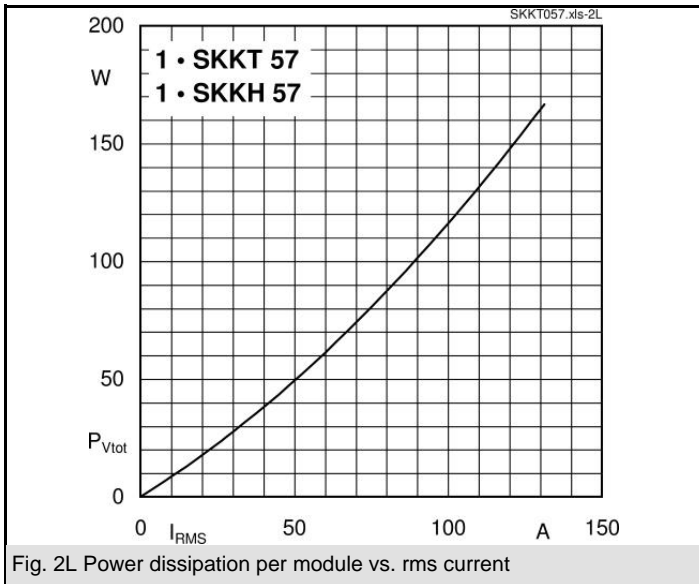
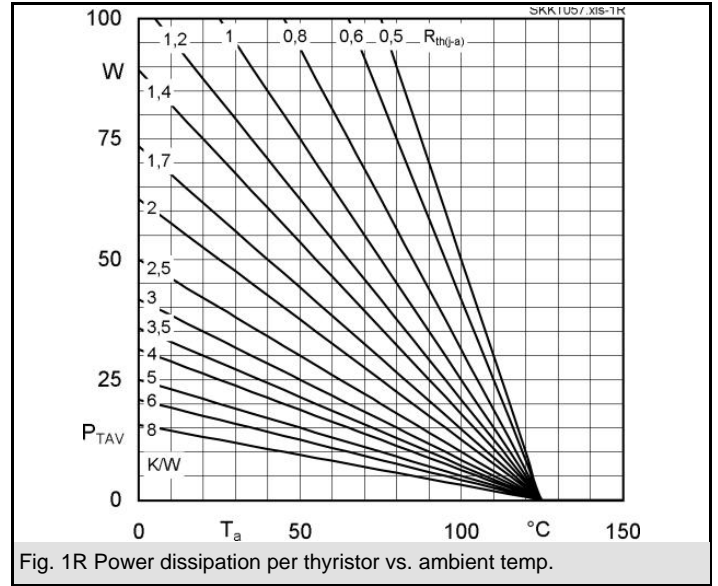
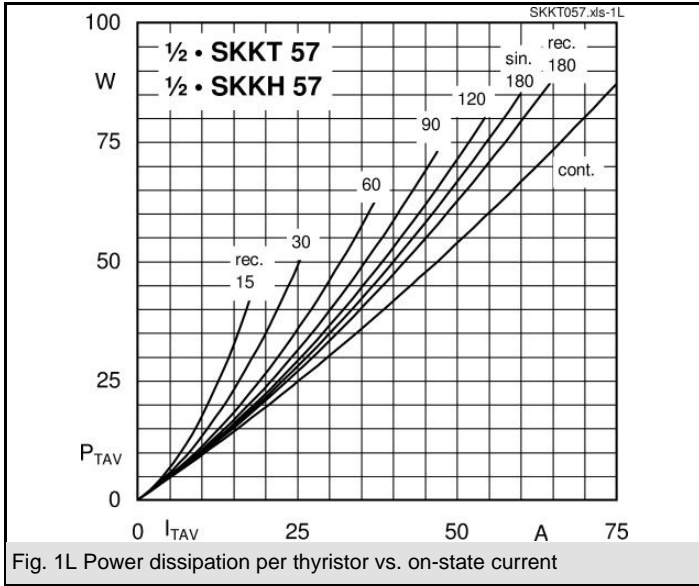

SKKT 57, SKKH 57, SKKT 57B

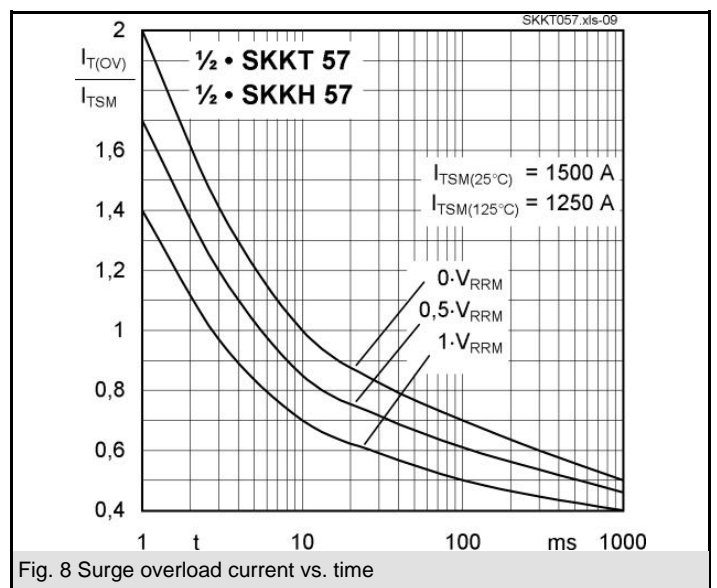
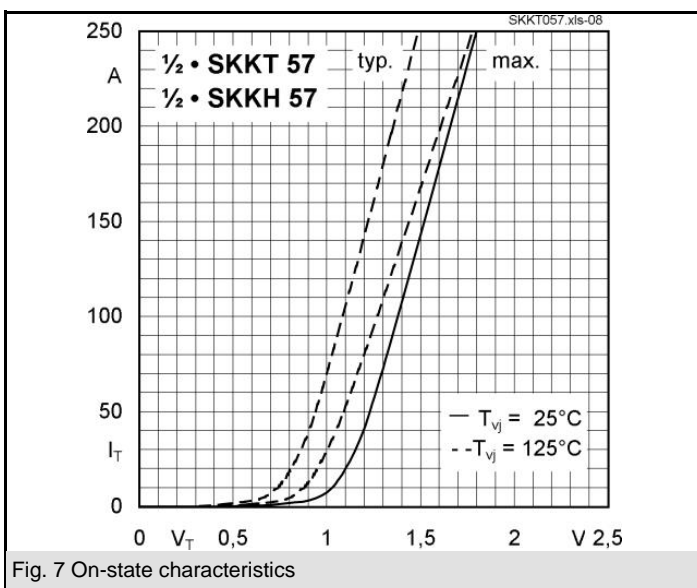
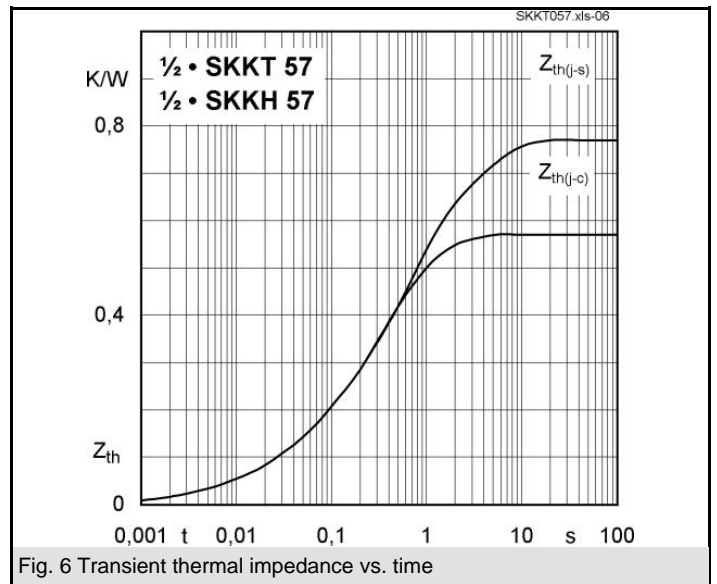
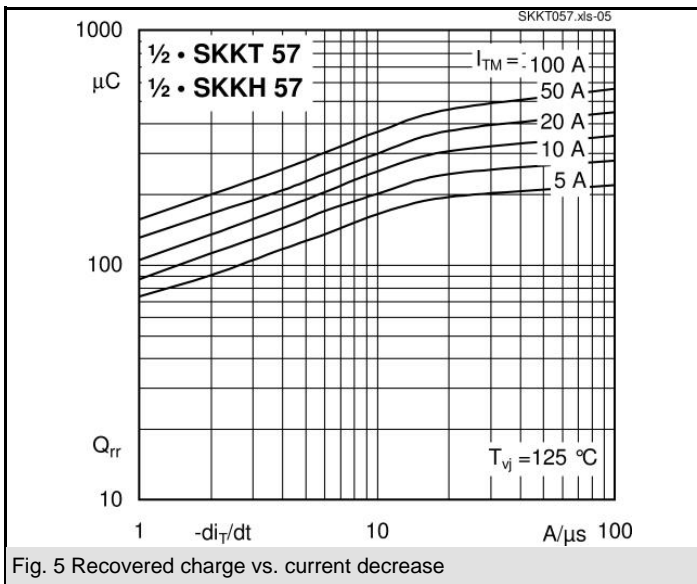
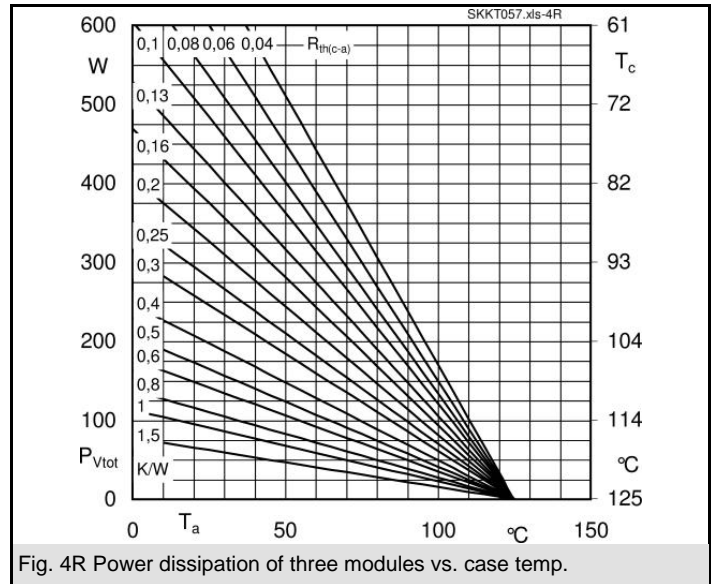
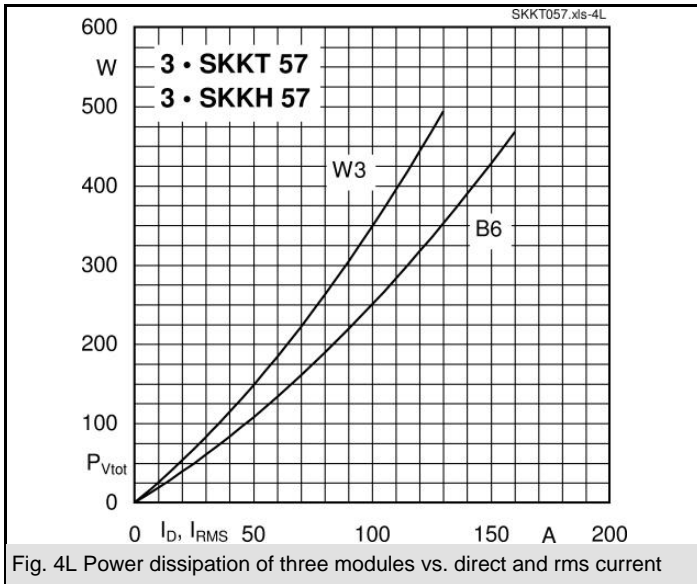

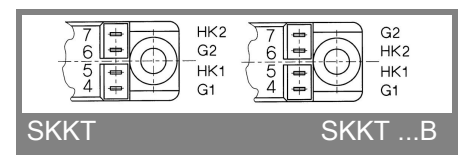
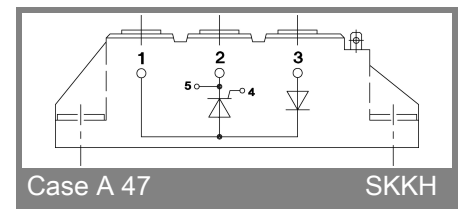
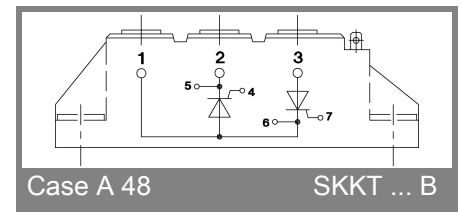
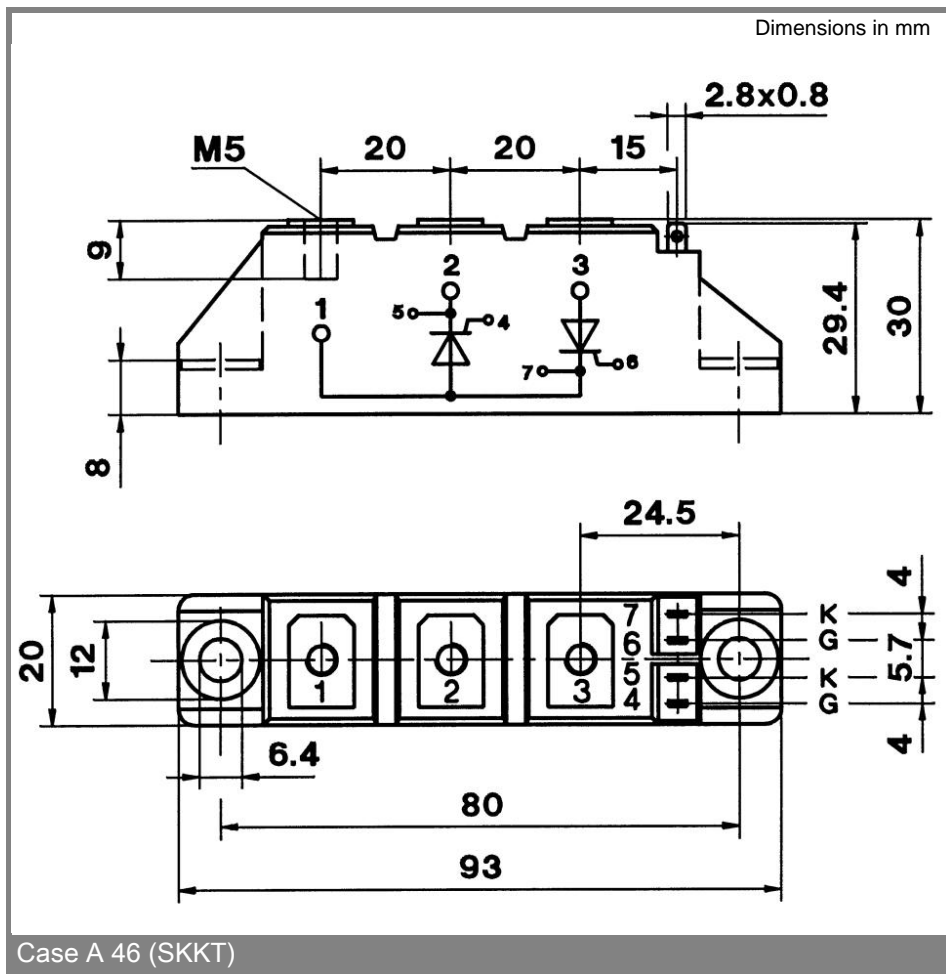
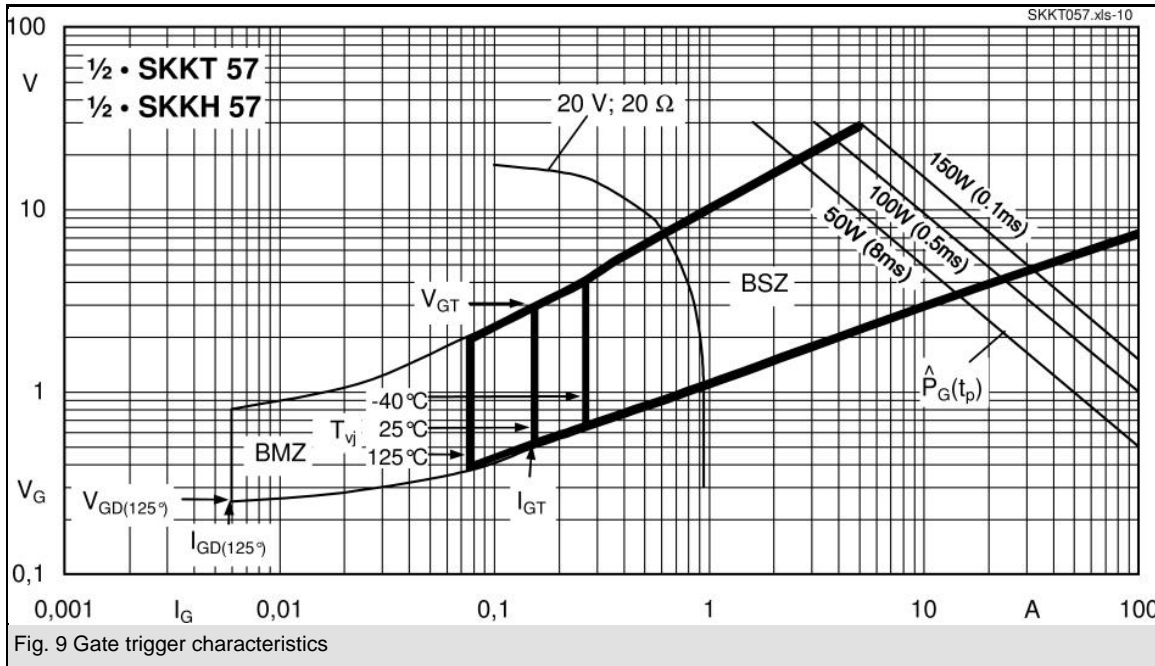

* The specifications of our components may not be considered as an assurance of component characteristics. Components have to be tested for the respective application. Adjustments may be necessary. The use of SEMIKRON products in life support appliances and systems is subject to prior specification and written approval by SEMIKRON. We therefore strongly recommend prior consultation of our staff.