

# SKN 240, SKR 240



## Stud Diode

## Rectifier Diode

### SKN 240

### SKR 240

### Features

- Reverse voltages up to 1800 V
- Hermetic metal case with glass insulator
- Threaded stud ISO M16 x 1,5
- SKN / SKR 240/04 ... /16 also available with threaded stud 3/4 - 16 UNF (e.g. SKR 240/12 UNF)
- SKN: anode to stud, SKR: cathode to stud

### Typical Applications\*

- All-purpose mean power rectifier diodes
- Cooling via heatsinks
- Non-controllable and half-controllable rectifiers
- Free-wheeling diodes
- Recommended snubber network:  
RC: 0,5  $\mu$ F, 30  $\Omega$  ( $P_R = 2W$ ),  
 $R_P = 50$  k $\Omega$  ( $P_R = 20 W$ )

$V_{RSM}$ V	$V_{RRM}$ V	$I_{FRMS} = 500$ A (maximum value for continuous operation) $I_{FAV} = 240$ A (sin. 180; $T_c = 125$ °C)	
400	400	SKN 240/04	SKR 240/04
800	800	SKN 240/08	SKR 240/08
1200	1200	SKN 240/12	SKR 240/12
1400	1400	SKN 240/14	SKR 240/14
1600	1600	SKN 240/16	SKR 240/16
1800	1800	SKN 240/18	SKR 240/18

Symbol	Conditions	Values	Units
$I_{FAV}$	sin. 180; $T_c = 100$ °C	320	A
$I_D$	K 0,55; $T_a = 45$ °C; B2 / B6	340 / 480	A
	K 0,55F; $T_a = 35$ °C; B2 / B6	620 / 840	A
$I_{FSM}$	$T_{vj} = 25$ °C; 10 ms	6000	A
	$T_{vj} = 180$ °C; 10 ms	5000	A
$i^2t$	$T_{vj} = 25$ °C; 8,3 ... 10 ms	180000	A <sup>2</sup> s
	$T_{vj} = 180$ °C; 8,3 ... 10 ms	125000	A <sup>2</sup> s
$V_F$	$T_{vj} = 25$ °C; $I_F = 750$ A	max. 1,4	V
$V_{(TO)}$	$T_{vj} = 180$ °C	max. 0,85	V
$r_T$	$T_{vj} = 180$ °C	max. 0,6	m $\Omega$
$I_{RD}$	$T_{vj} = 180$ °C; $V_{RD} = V_{RRM}$	max. 60	mA
$Q_{tr}$	$T_{vj} = 160$ °C; $-di_F/dt = 10$ A/ $\mu$ s	200	$\mu$ C
$R_{th(j-c)}$		0,2	K/W
$R_{th(c-s)}$		0,03	K/W
$T_{vj}$		- 40 ... + 180	°C
$T_{stg}$		- 55 ... + 180	°C
$V_{isol}$		-	V~
$M_s$	to heatsink	30	Nm
a		5 * 9,81	m/s <sup>2</sup>
m	approx.	250	g
Case		E 15	

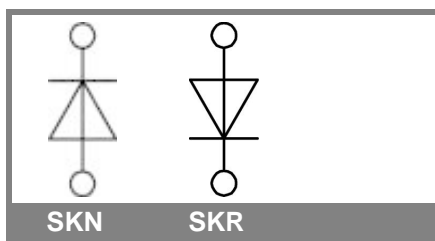

SKN

SKR

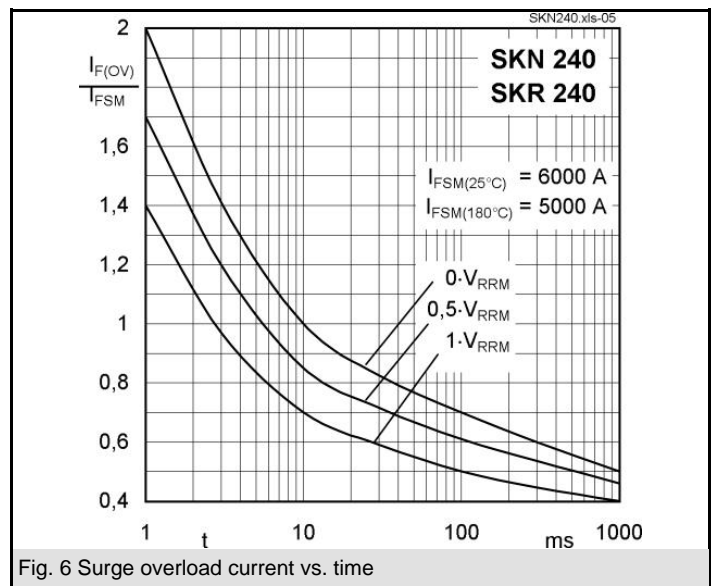
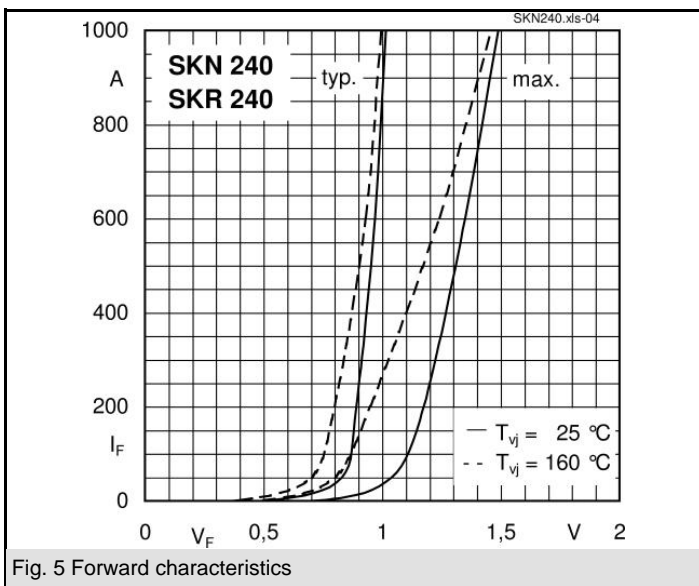
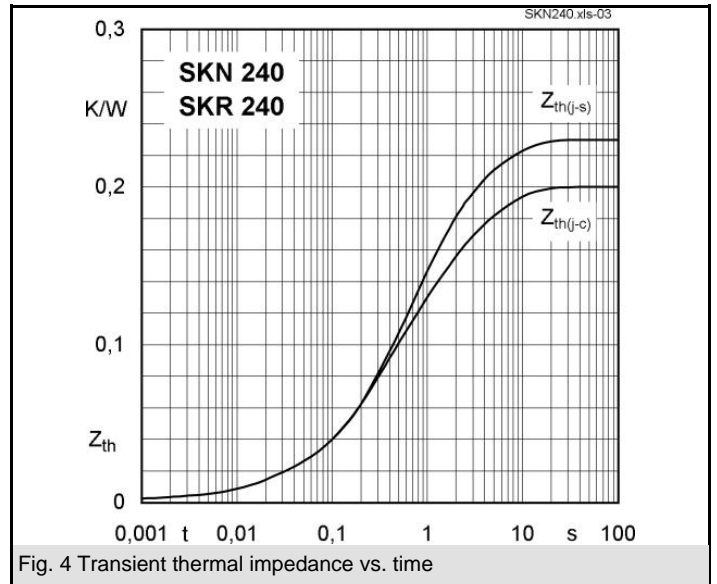
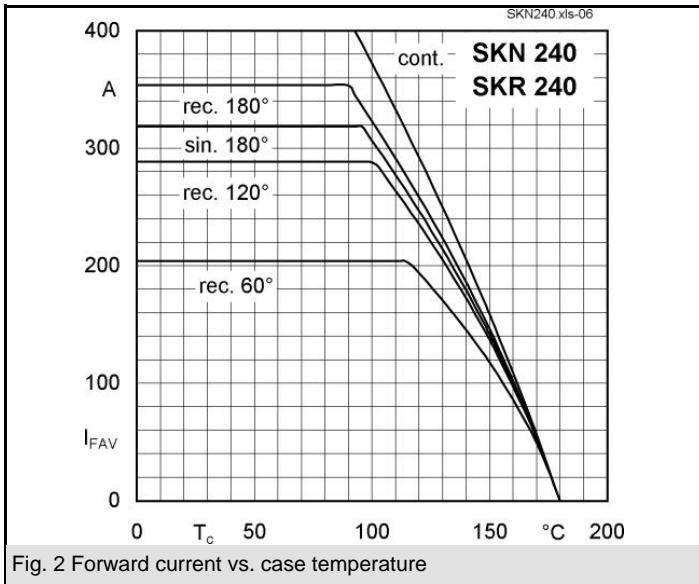
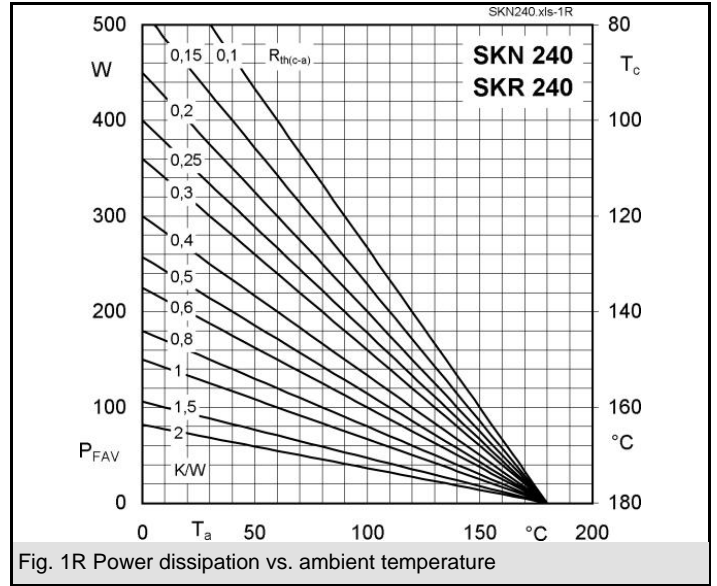
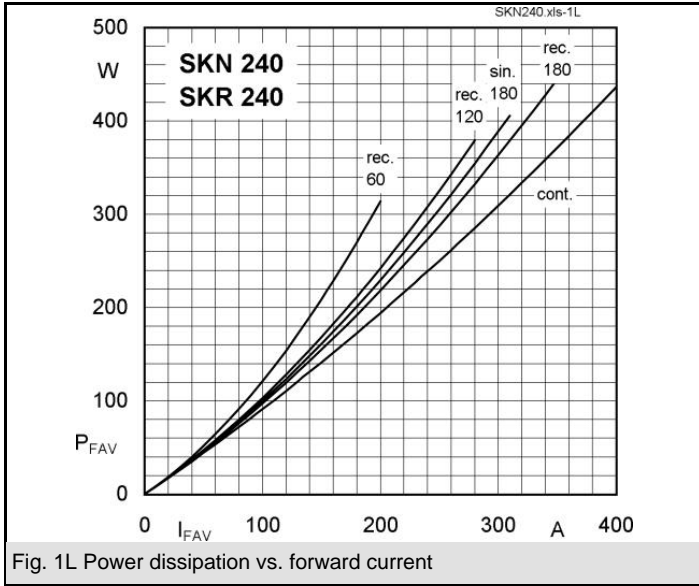

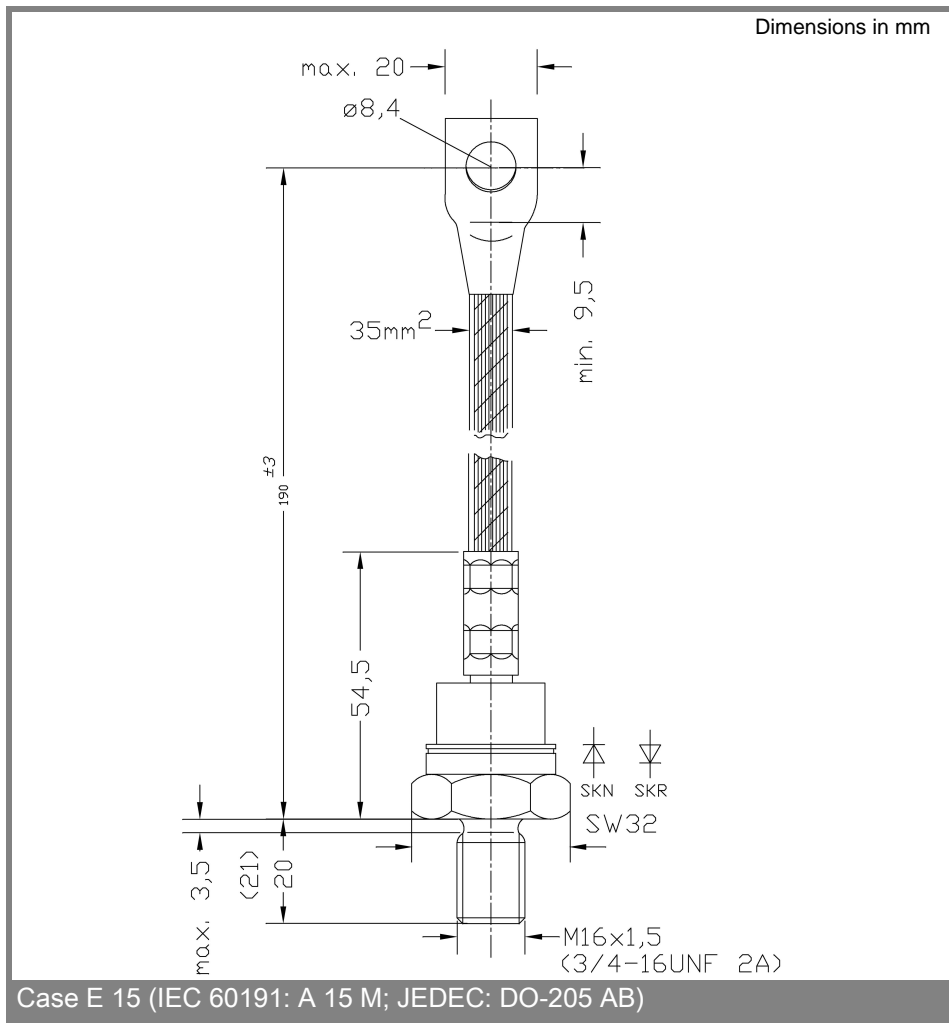

\* The specifications of our components may not be considered as an assurance of component characteristics. Components have to be tested for the respective application. Adjustments may be necessary. The use of SEMIKRON products in life support appliances and systems is subject to prior specification and written approval by SEMIKRON. We therefore strongly recommend prior consultation of our personal.