

Solar Light Controller

USER MANUAL

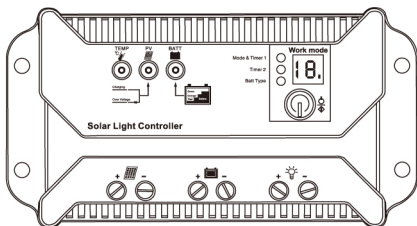

Specification Summary

Nominal system voltage: 12/24V DC

Maximum PV input voltage: 50V

Nominal charge/discharge current:

RXT-124-05 5A

RXT-124-10 10A

RXT-124-15 15A

RXT-124-20 20A

* The controller will automatically recognize the system rated voltage when start up. If the battery voltage is lower than 18V, it will recognize the system as 12V. If the battery voltage is higher than 18V, it will recognize the system as 24V.

1. Important Safety Information

1.1 Save these instructions

This manual contains important safety, installation and operation instructions. The following symbols are used throughout this manual to indicate potentially dangerous conditions or mark important safety instructions. Please take care when meet with these symbols.

 **Warning:** indicates a potentially dangerous condition. Use extreme caution when perform this task.

 **Caution:** Indicates a critical procedure for safe and proper operation of the controller.

 **Note:** Indicates a procedure or function that is important for the safe and proper operation of the controller.

1.2 General safety information

- * Read all of the instructions and cautions in the manual before beginning installation.
- * There are no user serviceable parts inside the controller. Do not assemble or attempt to repair it.
- * Install external fuses/breakers as required.
- * Disconnect the solar module and fuse/breakers near to battery before installing or adjusting the controller.
- * Confirm that power connections are tightened to avoid excessive heating from loosen connection.

2. General Information

2.1 Product overview

Thank you for selecting our SLC series solar light controller that adopts the most advanced digital technique and operates fully automatically. The pulse width modulation (PWM) batteries charging can greatly increase the lifetime of battery. It has various unique functions and quite easy to use, such as:

- * 12/24V automatic recognition.
- * High efficient series PWM charging, increase the battery lifetime and improve the solar system performance.
- * Use MOSFET as electronic switch, without any mechanical switch.
- * Widely used, automatically recognize day / night.
- * Digital LED menu, only one key solve all settings simply.
- * Intelligent timer function with 1-15 hours options.
- * Unique dual timer function, enhance the flexibility of street light system.
- * Gel, Sealed and Flooded battery type optional.
- * Adopt temperature compensation, correct the charging and discharging parameters automatically and improve the battery lifetime.
- * Electronic protection: overheating, over charging, over discharging, overload, and short circuit.
- * Polarity reverse protection: any combination of solar module and battery.

The controller is for off-grid solar system, especially in solar light system, and protects the battery from being over charged by the solar module and over discharged by the loads. The charging process has been optimized a long battery life and improved system performance. The comprehensive self-diagnostics and electronic protection functions can prevent damage

from installation mistakes or system faults.

Even though the controller is easy to operate and use, please take your time to read this manual and become familiar with it. This will help you make full use of all the functions and improve your solar PV system.

2.2 Products indication

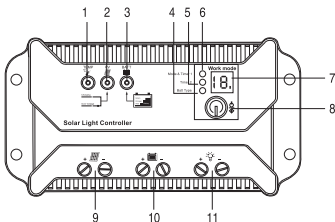

Figure 1 - Solar light controller characteristics

- 1- Temperature sensor:** measure ambient temperature and make temperature compensation for charging and discharging.
- 2- Charging status LED indicator:** an LED indicator that shows charging status and also indicates when battery voltage is higher than over voltage disconnect voltage.
- 3- Battery status LED indicator:** an LED indicator that shows battery status.
- 4- Battery typesetting indicator:** the indicator will be on when select battery type.
- 5- Timer 2 setting indicator:** the indicator will be on when set timer 2.
- 6- Timer 1 setting indicator:** the indicator will be on when set timer 1.
- 7- LED digital display:** display the load work mode and status.
- 8- Setting button:** set load work mode and select battery type (in manual mode used for load ON/OFF)
- 9- Solar module terminals:** connect solar modules.
- 10- Battery terminals:** connect batteries.
- 11- Load terminals:** connect loads.

3. Installation Instructions

3.1 General installation notes

Read through the entire installation section first before installation, be very careful when working with batteries. Wear eye protection. Have fresh water available to wash and clean any contact with battery acid. Uses insulated tools and avoid placing metal objects near the batteries. Explosive battery gasses may be present during charging. Be certain there is sufficient ventilation to release the gasses. Avoid direct sunlight and do not install in locations where water can enter the controller. Loosen power connections and/or corroded wires may result in resistive connections that melt wire insulation, burn surrounding materials, or even cause fire. Ensure tight connections and use cable clamps to secure cables and prevent them from swaying in mobile applications. Use with GEL, Sealed or Flooded batteries only. Battery

connection may be wired to one battery or a bank of batteries. The following instructions refer to a singular battery, but it is implied that the battery connection can be made to either one battery or a group of batteries in a battery bank. Select the system cables according to $3A/mm^2$ current density.

3.2 Mounting

Note: when mounting the controller, ensure free air through the controller heat sink fins. There should be at least 5.9 inches (150mm) of clearance above and below the controller to allow for cooling. If mounted in an enclosure, ventilation is highly recommended.

Warning: Risk of explosion! Never install the controller in a sealed enclosure with flooded batteries! Do not install in a confined area where battery gas can accumulate.

Step 1: Choose mounting location

Locate the controller on a vertical surface protected from direct sun, high temperature, and water. And make sure good ventilation.

Step 2: Check for clearance

Place the controller in the location where it will be mounted. Verify that there is sufficient room to run wires and that there is sufficient room above and below the controller for air flow.

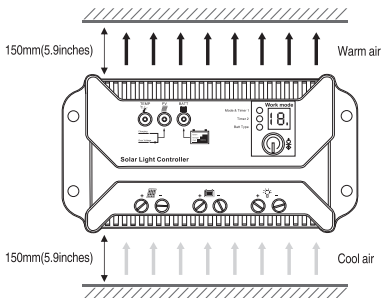

Figure 2- Mounting and cooling

Step 3: Mark holes

Use a pencil or pen to mark the four (4) mounting holes locations on the mounting surface.

Step 4: Drill holes

Remove the controller and drill 4mm holes in the marked locations.

Step 5: Secure controller

Place the controller on the surface and align the mounting holes with the drilled holes in step 4. Secure the controller in place using the mounting screws.

3.3 Wiring

Note: A recommended connection order has been provided for maximum safety during

installation.

Note: The controller is a common positive ground controller.

Caution: Don't connect the loads with surge power exceeding the rating of the controller

Caution: For mobile applications, be sure to secure all wiring. Use cable clamps to prevent cables from swaying when the vehicle is in motion. Unsecured cables create loose and resistive connections which may lead to excessive heating and/or fire.

Step 1: Battery wiring.

WARNING: Risk of explosion or fire! Never short circuit battery positive (+) and Negative (-) or cables.

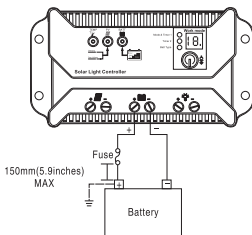

Figure 3- Battery connecting

Before battery is connected, make sure that battery voltage is greater than 6V so as to start up the controller. If system is 24V, make sure battery voltage is not less than 18V. System voltage can only be automatically recognized when controller start up for the first time.

When install fuse, make sure that the biggest distance between the fuse holder and the positive terminal of battery is 150mm. Do not insert a fuse at this time. Confirm the connection correct and turn on the power.

Step 2: Load wiring

The controller loads can be connected to such electrical equipment as lights, pumps, motors and others. Controller offers power to loads through the battery voltage.

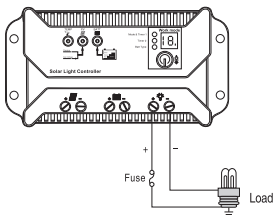

Figure 4- Load wiring

Connect the positive (+) and negative (-) of loads to controller load terminals as shown in figure 4. The load terminal may exist voltage, connect carefully to avoid short circuit.

An in-line fuse holder should be wired in series in the load positive (+) or negative (-) wire as show in figure 4. Do not insert a fuse at this time. Confirm the connection correct and turn on the power. If wiring the load connection to a load distribution panel, each load circuit should be fused separately. The total load draw should not exceed the load rated current of controller.

Step 3: Solar panel wiring

⚠️ WARNING: Risk of electric shock! Exercise caution when handling solar wiring. The solar modules high voltage output can cause severe shock or injury. Be careful operation when installing solar wiring.

The controller can accept 12V, 24V nominal off-grid solar modules. Grid-tie solar modules may be used if the open circuit voltage of solar module doesn't exceed the maximum PV input voltage of the controller. The solar modules working voltage must be equal to or higher than the system voltage.

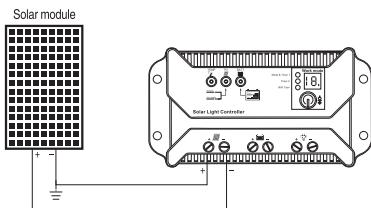

Figure 5 Solar panel wiring

Step 4: Confirm wiring

Double-check the wiring in step1 through 3. Confirm correct polarity at each connection. Verify that all six terminals are tighten.

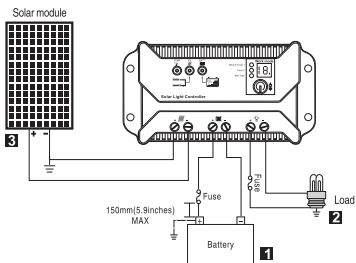

Figure 6- System wiring review

Step 5: Confirm power on

When battery power is applied and the controller starts up, the battery LED indicator will be green. If the controller doesn't start up, or the battery status LED error exists, please refer to section 5 for troubleshooting.

4. PWM Charging Information

4.1 PWM technology (Pulse Width Modulation): the controller adopts the advanced series pulse width modulation (PWM) charging mode. With range of 0-100%, it can charge the battery quickly and stably under any condition of solar photovoltaic system. PWM charging mode use automatic conversion duty ratio pulses current to charge the battery. The battery can be fully charged safety and rapidly with the pulse current. Intermissions make some oxygen and hydrogen generated by chemical reaction chemically combined again and absorbed. It can eliminate concentration polarization and ohm polarization naturally and reduce the internal pressure of the battery so that the battery can absorb more power. Pulse current charging mode makes battery have more time to react, which reduces the gassing volume and makes battery improve the acceptance rate of charging current.

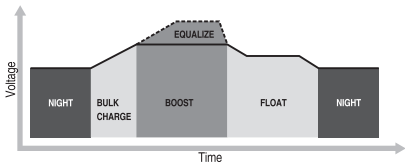

Figure 7 PWM charging mode

4.2 Bulk Charge: in this stage, the battery voltage has not yet reached boost voltage and 100% of available solar power is used to charge the battery.

4.3 Boost charge: when the battery has reached to the boost voltage set point, constant current regulation is used to prevent heating and excessive battery gassing. The boost stage remains 120minutes and then goes to float charge.

4.4 Float Charge: after the battery is fully charged in boost voltage stage, the controller reduces the battery voltage to float voltage set point. When the battery is fully charged, there will be no more chemical reactions and all the charge current transmits into heat and gas at this time. Then the controller reduces the voltage to the floating stage, charging with a smaller voltage and current. It will reduce the temperature of battery and prevent the gassing, also charging the battery slightly at the same time. The purpose of float stage is to offset the power consumption caused by self consumption and small loads in the whole system, while maintaining full battery storage capacity. In float stage, loads can continue to draw power from the battery. In the event that the system load(s) exceed the solar charge current, the controller will no longer be able to maintain the battery at the float set point. Should the battery voltage remains below the boost reconnect charging voltage, the controller will exit float stage and return to bulk charge.

4.5 Equalize Charge: certain types of batteries benefit from periodic equalizing charge, which can stir the electrolyte, balance battery voltage and complete chemical reaction. Equalizing charge increases the battery voltage, higher than the standards complement voltage, which gasifies the battery electrolyte. If the battery is being over discharged, the solar controller will automatically turn to equalize charging stage, and the equalize stage remain 120mins.

Equalize charge and boost charge are not carried out constantly in a full charge process to avoid too much gas precipitation or overheating of battery.

Warning: Risk of explosion! Equalizing flooded battery can produce explosive gases, so well ventilation of battery box is necessary.

Note: Equipment damage! Equalization may increase battery voltage to the level damaging to sensitive DC loads. Ensure that all loads allowable input voltage are higher than the equalizing charging set point voltage.

Note: Equipment damage! Over-charging and excessive gas precipitation may damage the battery plates and activate material shedding on them. Too high an equalizing charge or for too long may cause damage. Please carefully review the specific requirements of the battery used in the system.

5. LED Indicators

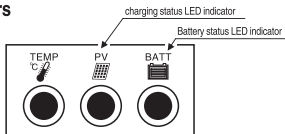

Figure 8 LED indicators

5.1 Charging status indicator

Green ON whenever sunlight is available for battery charging.

Color	Indicator	Charging status
Green	On solid	Charging

5.2 Battery status indicator

Green ON when battery voltage in normal range.

Green slowly flashing when battery full

Orange ON when battery under voltage

Red ON when battery over discharged.

Color	Indicator	Battery status
Green	On solid	Normal
Orange	On solid	Under voltage
Red	On solid	Over discharged

6. Setting Operation

6.1 Dual timer function



The default night length is 10 hours. The controller can learn the night length referring to the

previous night so as to adapt to the different seasons. However, it takes some time to lean it.

Notes: when the OFF time set at timer 2 is later than local sunrise time, the controller will turn off the load output at the sunrise time, which shows light control first!

6.2 Load control settings

6.2.1 Dusk to dawn

When solar module voltage goes below the point of NTVV (night time threshold voltage) at sunset, the controller will recognize the starting voltage and turn on the load after 10minutes delay. When solar module voltage goes above point of DTTV (day time threshold voltage), the solar controller will recognize the starting voltage and turn off the load after 10minutes delay.

6.2.2 Light ON + timer

When solar module voltage goes below the point of NTVV (night time threshold voltage) at sunset, the solar controller will recognize the starting voltage and turn on the load after 10minutes delay. The load will be on for several hours which users set through LED digital tube.

6.2.3 Testing mode

This mode is the same as Dusk to Dawn. But there is no 10minutes delay when controller recognizes the starting voltage. When below the starting voltage, the controller will turn on the load, if higher, it will turn off load. The test mode makes it easy to check the system installation.

6.2.4 Manual mode

This mode is to turn ON and OFF the load by manual.

7. Load Work Mode Setting

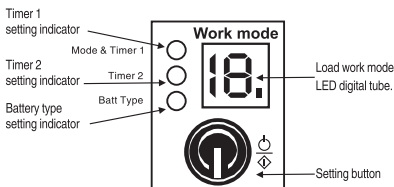

Figure 9 Setting operation indicating

Press the setting button once and setting indicators will be changed once among timer 1, timer 2 and battery type.

When timer 1 setting indicator is on, press the setting button for more than 5 seconds till the LED digital tube flashes. Then press the setting button till the desired number appears according to the following table. The setting is finished when the digital tube stop flashing.

Timer 2 setting is the same as timer1 when the setting indicator is on timer 2.

Load work mode

Timer 1	LED digital No.
Disable	n
Dusk to dawn, load will be on all night	0
Load will be on for 1 hour after ten minutes delay since sunset	1
Load will be on for 2 hours after ten minutes delay since sunset	2
Load will be on for 3 hours after ten minutes delay since sunset	3
Load will be on for 4 hours after ten minutes delay since sunset	4
Load will be on for 5 hours after ten minutes delay since sunset	5
Load will be on for 6 hours after ten minutes delay since sunset	6
Load will be on for 7 hours after ten minutes delay since sunset	7
Load will be on for 8 hours after ten minutes delay since sunset	8
Load will be on for 9 hours after ten minutes delay since sunset	9
Load will be on for 10 hours after ten minutes delay since sunset	10
Load will be on for 11 hours after ten minutes delay since sunset	11
Load will be on for 12 hours after ten minutes delay since sunset	12
Load will be on for 13 hours after ten minutes delay since sunset	13
Load will be on for 14 hours after ten minutes delay since sunset	14
Load will be on for 15 hours after ten minutes delay since sunset	15
Test mode	16
ON/OFF mode	17

Load work mode

Timer 2	LED digital NO.
Disable	n
Load will be on for 1 hour before sunrise	1
Load will be on for 2 hours before sunrise	2
Load will be on for 3 hours before sunrise	3
Load will be on for 4 hours before sunrise	4
Load will be on for 5 hours before sunrise	5
Load will be on for 6 hours before sunrise	6
Load will be on for 7 hours before sunrise	7
Load will be on for 8 hours before sunrise	8
Load will be on for 9 hours before sunrise	9
Load will be on for 10 hours before sunrise	10
Load will be on for 11 hours before sunrise	11
Load will be on for 12 hours before sunrise	12
Load will be on for 13 hours before sunrise	13
Load will be on for 14 hours before sunrise	14
Load will be on for 15 hours before sunrise	15

 **Notes:** if timer 1 is dusk to dawn (0), test mode (16) or ON/OFF mode (17), the timer 2 will be disabled.

8. Battery Type Setting

When battery typesetting indicator is on, press the setting button for more than 5 seconds till the LED digital tube flashes, then press the setting button till the desired number appears according to the following table. The setting is finished till the LED digital display stops flashing.

Battery Type	Digital tube display
Gel battery	1
Sealed lead acid battery	2
Flooded battery	3

9. Protection

- * **PV array short circuit:** If PV array short circuit occurs, clear it to resume normal operation.
- * **Load overload:** If the load current exceeds the maximum load current rating, the controller will disconnect the load. Overloading must be cleared up through reapply power or pressing the setting button.
- * **PV reverse polarity:** Fully protected against PV reverse polarity, no damage to the controller will result. Correct the miswire to resume normal operation.
- * **Battery reverse polarity:** Fully protection against battery reverse polarity, no damage to the controller will result. Correct the miswire to resume normal operation.
- * **Damaged local temperature sensor:** If the temperature sensor short-circuit or damaged, the controller will be charging or discharging at the default temperature 25°C to prevent the battery damaged from overcharging or over discharged.
- * **Overheating protection:** If the temperature of the controller heat sink exceeds 85°C , the controller will automatically start the overheating protection.
- * **High voltage transients:** PV is protected against high voltage transients. In lightning prone areas, additional external suppression is recommended.

10. Troubleshooting

Faults	Possible reasons	Troubleshooting
Charging LED indicator off during daytime when sunshine falls on PV modules properly.	PV array disconnection	Check the PV and battery wire connections are correct and tight.
Green charging LED indicator fast flashing	Battery voltage higher than over voltage disconnect voltage(OVD)	Check if battery voltage over high, disconnect the solar module
Battery LED indicator are orange	Battery under voltage	Load output is normal, charging LED indicator will return to green automatically when fully charged.
Battery LED indicators red color and loads not working	Battery over discharged	The controller cut off the output automatically, LED indicator will return to green automatically when fully charged.

 **Notes:** No LED indicator. Measure battery voltage with multimeter. Min. 6V can start up the controller.

 **Notes:** No charging status LED indicator with normal connection. Measure the input voltage of solar module, the input voltage must be higher than battery voltage.

11. Technical Specifications

Model	RXT-124-05	RXT-124-10	RXT-124-15	RXT-124-20
Normal system voltage	12/24V DC auto. work			
Maximum battery voltage	32V			
Rated charge current	5A	10A	15A	20A
Charge circuit voltage drop	≤ 0.26V			
Discharge circuit voltage drop	≤ 0.15V			
Self-consumption	≤ 6mA			
NTTV(night time threshold voltage)	12V system: 5V			
	24V system: 10V			
DTTV(daytime threshold voltage)	12V system: 6V			
	24V system: 12V			
Temperature compensation coefficient(TEMPCO)*	-30mV/°C /12V(25°C ref) *compensation of equalization, boost, float and low voltage disconnect voltage.			
Working temperature	-35°C ~+55°C			
Storage temperature	-35°C ~+80°C			
Humidity	10%-90% NC			
Enclose	IP30			
Overall dimension	150x82x50mm			
Terminal	6mm ²			
Net weight	0.35kg			

Battery voltage parameters (Temperature at 25°C)

Charging parameters			
Battery charging setting	Gel	Sealed	Flooded
Over voltage disconnect voltage	16V; × 2/24V		
Charging limit voltage	15.5V; × 2/24V		
Over voltage reconnect voltage	15V; × 2/24V		
Equalize charging voltage	14.4V; × 2/24V	14.6V; × 2/24V	14.8V; × 2/24V
Boost charging voltage	14.2V; × 2/24V	14.4V; × 2/24V	14.6V; × 2/24V
Floating charging voltage	13.8V; × 2/24V		
Boost reconnect charging voltage	13.2V; × 2/24V		
Low voltage reconnect voltage	12.6V; × 2/24V		
Under voltage warning reconnect voltage	12V; × 2/24V		
Low voltage disconnect voltage	11.1V; × 2/24V		
Discharging limit voltage	10.8V; × 2/24V		
Equalization duration	2 hours		
Boost duration	2 hours		

12. Warranty

The solar lighting controller is warranted to be free from defects for a period of 2 years from the date of shipment to the original end user. We will, at its option, repair or replace any such defective products.

12.1 Claim procedure:

Before requesting warranty service, check the operation manual to be certain that there is a problem with the controller. Return the defective product to us with shipping charges prepaid if problem cannot be solved. Provided proof of date and place of purchase. To obtain rapid service under this warranty, the returned products must include the model, serial number and

detailed reason for the failure, the module type and size, type of batteries and system loads, this information is critical to a rapid disposition of your warranty claim.

12.2 This warranty does not apply under the following conditions:

1. damage by accident, negligence, abuse or improper use.
2. PV or load current exceeding the rating of product.
3. Unauthorized product modification or attempted repair.
4. damaged occurring during shipment.
5. damage results from acts of nature such as lightning, weather extremes
6. Irreclaimable mechanical damaged.



13. Mounting Size

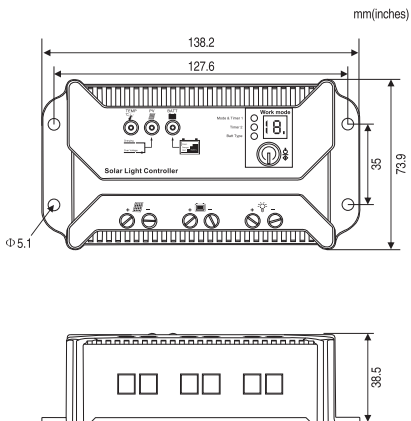

Figure 10 Mounting size



Final interpretation right of the manual belongs to our company. Any changes without prior notice!